

UNO-2271G V3

Pocket-Size Edge IoT Gateway with Intel® Atom x7211RE



Features

- Intel® Atom Dual core x7211RE processor with 8GB LPDDR5 onboard memory and 64 GB eMMC
- Pocket-size, robust, fanless and cable-free system with high stability
- Optional second stack for increasing functionality including POE, COM, wireless connectivity or iDoor expansion
- Support Windows 11 LTSC, Ubuntu 22.04; 24.04

Introduction

Advantech's UNO-2000 series of embedded automation computers are highly rugged, fanless systems. The modular design offers strong computing performance and flexible scalability with various I/O ports for IoT Connectivity. UNO-2271G V3 designed as IoT edge gateways, its pocket size design features versatile I/O ports and expansion options to support wire/wireless communication, and AI accelerators for IoT edge data analysis and processing. UNO-2271G V3 IoT edge gateway enables various industrial applications across multiple industries.

Specifications

General

- **Certification** CE, FCC, UL, CCC, BSMI
- **Dimensions (W x D x H)** 100 x 70 x 41.5 mm/3.9 x 2.8 x 1.63 in
- **Form Factor** Pocket size
- **Enclosure** Aluminum
- **Mount Options** Stand mount, Wall mount, VESA mount(optional), DIN rail mount (optional)
- **Weight (Net)** 0.5 kg/1.1 lb
- **Power Requirement** 10 ~ 30V_{DC}
- **Power Consumption** 12W (typical), 40W (max.)
- **Power Type** AT mode
- **Operating System** Windows 11 LTSC, Ubuntu 22.04; 24.04

System Hardware

- **BIOS** AMI UEFI x64
- **Watchdog Timer** Programmable interval timer, from 1 to 255 seconds
- **Processor** Intel® Atom Dual core x7211RE
- **Memory** 8 GB LPDDR5 onboard
- **Graphics Engine** Intel® UHD Graphics
- **Ethernet** 2 x Intel® i226-IT GbE, IEEE 802.3AZ/802.1AS
- **LED Indicators** Power, RUN, LAN (active, status)
- **Storage** Onboard 64GB eMMC
Optional 1 x M.2 B+M key 2242 (SATA/PCIe)
- **Expansion** 1 x M.2_B key (w/PCIex1/SATA/USB3.2)
- **Hardware Security** TPM2.0 (TPM2.0 Library Revision 1.38)

I/O Interfaces

- **LAN Ports** 2 x 10/100/1000/2500BASE-T Fast Ethernet (RJ45)
- **USB Ports** 1x USB 3.2 Gen2 X1
1 x USB Type C (1.5A), supports DP & USB, DP ALT mode
- **Display Output** 1 x HDMI (1920 x 1080 @60Hz)
- **Power Connector** 1 x 2-pin terminal block

Environment

- **Operating Temperature** -20 ~ 60 °C (-4 ~ 140 °F) with 0.7m/s airflow
- **Storage Temperature** -40 ~ 85 °C /-40 ~ 185 °F
- **Relative Humidity** Operating , 95% RH @ 40° C, Non-Condensing
Non-Operating, 95% RH @ 60° C, Non-Condensing
- **Shock Protection** Operating, IEC 60068-2-27, 50G, half sine, 11 ms
- **Vibration Protection** Operating, IEC 60068-2-64, 2 Grms, random
- **Ingress Protection** IP30

Installation Scenarios

Stand/Wall Mount

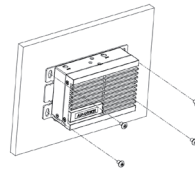

VESA Mount (optional)

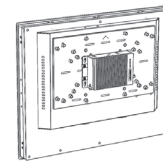

DIN-Rail Mount at the Rear Side (optional)

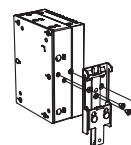
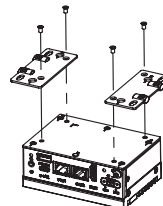
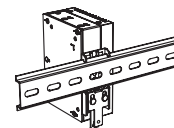
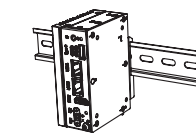

Dimensions

Unit: mm

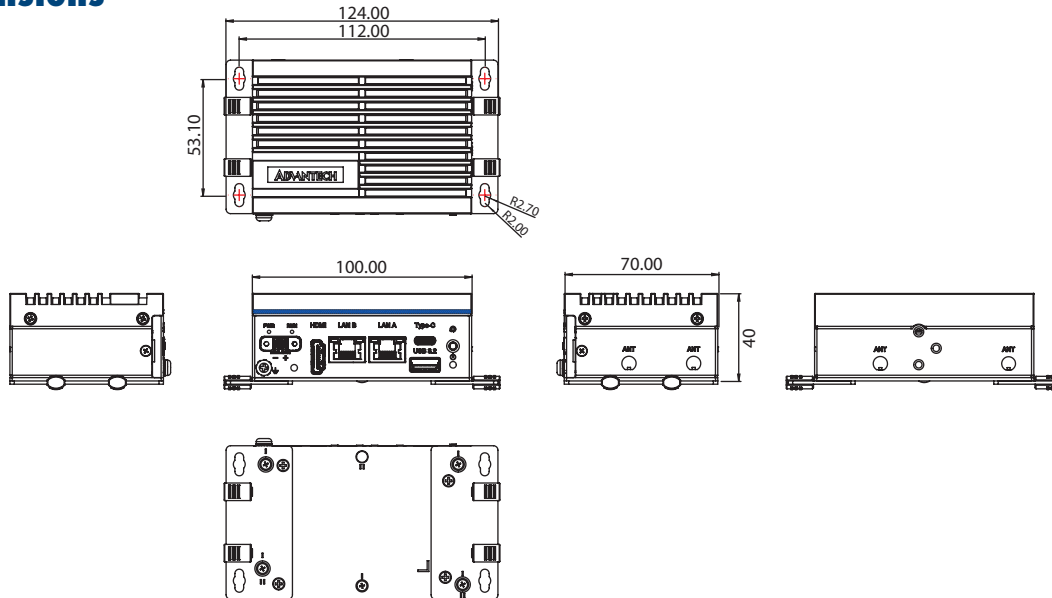

Front I/O

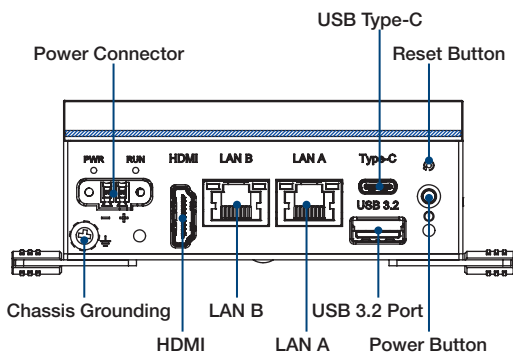

Side I/O

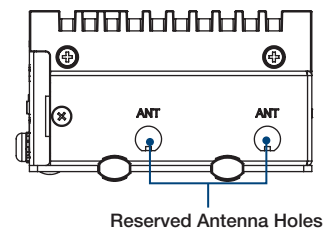

Ordering Information

- UNO-2271G-I331AE Intel® Atom® x7211RE 8 GB Ram, 64 GB eMMC, 2 x GbE, 1 x USB3.2, 1 x USB Type-C, 1 x HDMI, 1 x M.2 Bkey

Embedded OS

- 20701WLE1S0015 WIN11 LTSC v7.01 B024 for UNO-2271G_V3 Entry
- TBC AdvLinux 22.04
- TBC AdvLinux 24.04

Optional Accessories

Extension Kits

- UNO-2271G-EKDE 2nd stack extension kit for iDoor
- UNO-2271G-RP1EB 2nd stack extension kit for POE PD, COM, M.2 B key
- UNO-2271G-RS2EB 2nd stack extension kit for 2xCOM, M.2 B+E key

Adapters and Power Cables

- 96PSA-A60W24T2-3 60W AC to DC UNO series power adapter
- 1702002600 Power cable (US) 1.8 M
- 1702002605 Power cable (EU) 1.8 M
- 1702031801 Power cable (UK) 1.8 M
- 1700000596 Power cable (China/Australia) 1.8 M

Mount Kits

- UNO-2000G-DMKBE UNO-2271G V3 DIN-rail mount kit
- UNO-2000G-VMKAE UNO-2000 VESA mount kit

Miscellaneous

- UNO-2000-LKAE Cable lock kit, 10 units per pack
- 9891P383000 M.2 for 2242 B+M to E key convertor
- AIW-166K3 Intel AX210 802.11ax+BT5.2

Extension Kits

UNO-2271G-EKDE

Second stack extension kit for iDoor technology

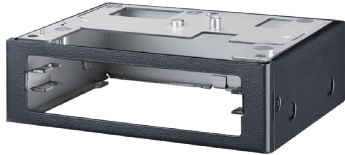

Front I/O

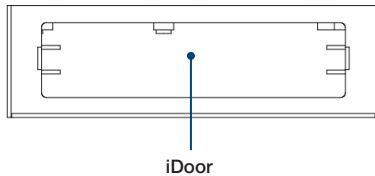

Specifications

General	
I/O	1 x iDoor slot (chassis only)
Dimensions	100 x 70 x 30 mm/ 3.93 x 2.75 x 1.18 in
Weight	100 g/0.22 lb
Environment	
Operating Temperature	Dependent on iDoor module installed

Ordering Information

Part Number	Description
UNO-2271G-EKDE	UNO-2271G V3 2nd stack extension kit for iDoor

Optional iDoor Modules*

Part Number	Description
PCM-34D2R4-AE	2-port isolated RS-422/485, M.2 B key (2242, USB 2.0), DB9
PCM-34D2R2-AE	2-port isolated RS-232, M.2 B key (2242, USB 2.0), DB9
PCM-34D4R4-AE	4-port non-isolated RS-422/485, M.2 B key (2242, USB 2.0), DB37 cable
PCM-34D4R2-AE	4-port non-isolated RS-232, M.2 B key (2242, USB 2.0), DB37 cable
PCM-34R1TP-AE	1-port Gigabit Ethernet, Intel® i225, M.2 B+M key (3042 ,PCIe*1), RJ45
PCM-34R2GL-AE	2-port Gigabit Ethernet, Intel® i350, M.2 B+M key (2242, PCIe*1), RJ45
PCM-37D24DI-AE	24-channel isolated digital I/O, M.2 B+M key (3042, PCIe*1), DB37

*Contact Advantech for more compatible iDoor solutions.

UNO-2271G-RP1EB

Second stack module with 2 x COM, 1 x PoE (PD), 1 x M.2 (B key)



Front I/O

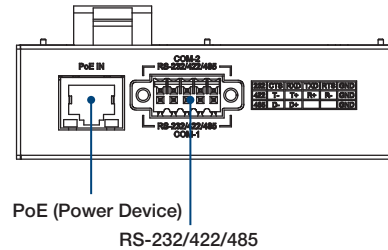

Specifications

General	
I/O	2 x COM (RS-232/422/485) terminal block 1 x PoE+ (802.3at) (power device) Note: Because PoE can only provide 25.5W max. power, USB ports should only be used to connect USB 2.0 devices.
Expansion	1 x M.2 (B key) (SATA/USB 3.0 signals for LTE)
SIM Slot	1 x nano SIM slot
Dimensions	100 x 70 x 30 mm/ 3.93 x 2.75 x 1.18 in
Weight	120 g/0.26 lb
Environment	
Operating Temperature	-20 ~ 60 °C/-4 ~ 140 °F

Ordering Information

Part Number	Description
UNO-2271G-RP1EB	UNO-2271G V3 second stack module with 2 x COM, 1 x PoE, 1 x M.2 (B key)

UNO-2271G-RS2EB

Second stack module with 2 x COM,
1 x M.2 (B key), 1 x M.2 (E key)



Front I/O

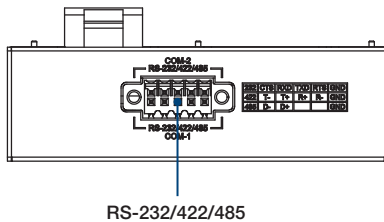

RS-232/422/485

Specifications

General	
I/O	2 x COM (RS-232/422/485) terminal block
Expansion	1 x M.2 (B key) (SATA/USB 3.0 signals for LTE) 1 x M.2 (E key) (PCIe/USB 2.0 signals for Wi-Fi)
Network Connectivity	1 x nano SIM slot
Dimensions	100 x 70 x 30 mm/ 3.93 x 2.75 x 1.18 in
Weight	120 g/0.26 lb
Environment	
Operating Temperature	-20 ~ 60 °C/-4 ~ 140 °F

Ordering Information

Part Number	Description
UNO-2271G-RS2EB	UNO-2271G V3 second stack module with 2 x COM, 2 x M.2 (B+E key)